

TOP MOUNTED CROSS ARM			
CATALOG #	FIXTURE QTY.	EPA (SQ. FT.)	WEIGHT (LBS.)
CRT-06	6	4.4	197

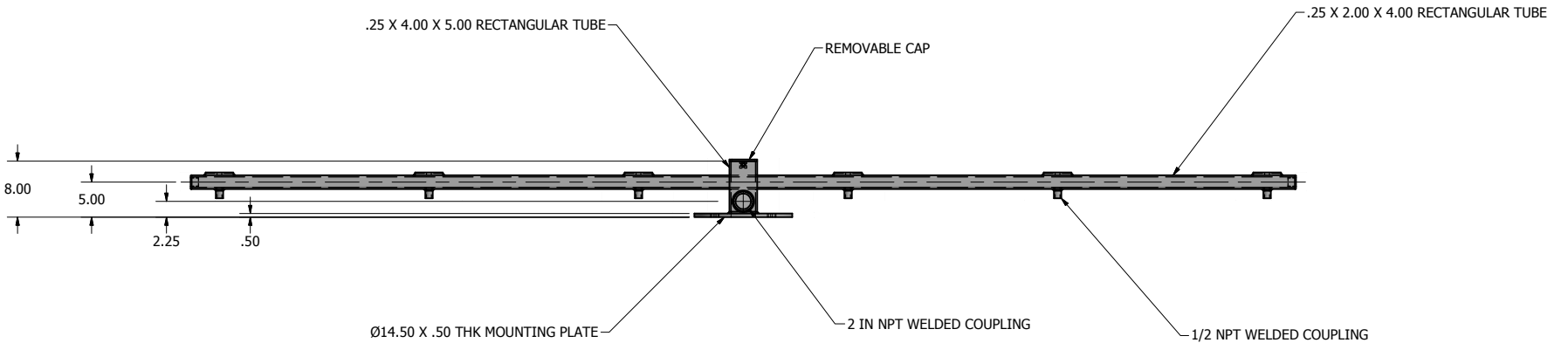
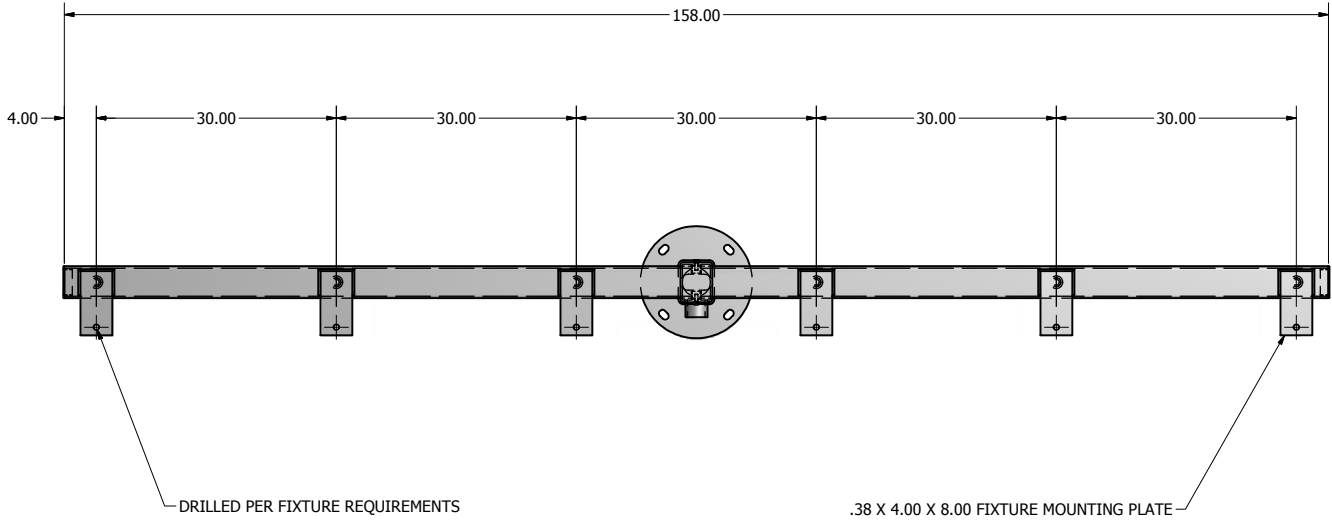

FINISH: TOP MOUNTED CROSS ARM BRACKET TO BE FINISHED TO MATCH POLE.

lyte poles
a DWM company

P.O. Box 340
Eastpointe, MI 48021
P: (586) 771-4610 | F: (586) 771-5527
www.lytepoles.com

DRAWN: M. HARVALA	2/16/2015
CHECKED	
REVISION:	DATE:
APPROVED:	
QUOTE:	
S.O.#	
REF:	SCALE: NONE

SOME GEOGRAPHICAL AREAS HAVE SPECIAL WIND CONDITIONS THAT CAN CREATE WIND INDUCED VIBRATIONS CAUSING A FATIGUE PROBLEM. NO METHOD HAS YET BEEN FOUND FOR PREDICTING DESTRUCTIVE LIGHTING POLE VIBRATION. THESE CONDITIONS ARE UNIQUE AND CANNOT BE GUARANTEED AGAINST, AND ARE THE RESPONSIBILITY OF A LOCAL SITE ENGINEER.		
TITLE:		
CATALOG:		
DWG NO: CRT-06	SIZE C	SHEET 1 OF 1

